



# Power Supply Units (AUTODOME VG5- and MIC IP Cameras)

VG4-A-PSU1 | VG4-A-PSU2



**BOSCH**



## Table of contents

<b>1</b>	<b>Safety</b>	<b>4</b>
1.1	Safety precautions	4
1.2	Important safety instructions	4
1.3	Important Notices	5
1.4	UL certification	6
1.5	Bosch notices	6
<b>2</b>	<b>Unpacking</b>	<b>8</b>
2.1	Parts List	8
2.2	Optional Parts List	8
2.3	Tools Required	8
<b>3</b>	<b>Description</b>	<b>9</b>
<b>4</b>	<b>Pre-installation Check List</b>	<b>10</b>
<b>5</b>	<b>Mount Power Supply Box (Wall, Mast (Pole), and Corner Mounts)</b>	<b>12</b>
<b>6</b>	<b>Attach Cover Door to Power Supply Box</b>	<b>14</b>
<b>7</b>	<b>Route Wires and Attach Connectors</b>	<b>15</b>
7.1	Methods for Routing Wires (AUTODOME Cameras ONLY)	15
7.2	Power Supply Box Connections	17
<b>8</b>	<b>Wiring the Power Supply Box</b>	<b>19</b>
<b>9</b>	<b>Video and Control Cables (AUTODOME VG5-600 Camera Models ONLY)</b>	<b>20</b>
9.1	Using Coaxial Cable to Transmit Video and Control	20
9.2	Using UTP to Transmit Video and Control	20
9.3	Using Ethernet to Transmit Video and Control	21
9.4	Using Multi-mode Fiber Optic to Transmit Video and Control	21
9.5	Using a Fiber Optic Ethernet Media Converter to Transmit Video and Control	22
9.6	Controlling the AUTODOME via Biphase	22
9.7	Controlling the AUTODOME via the RS232 Protocol	24
9.8	Controlling the AUTODOME via the RS-485 Protocol	25
<b>10</b>	<b>Fiber Optic Module with an RS232/RS422 Controller (AUTODOME VG5-600 Camera Models ONLY)</b>	<b>28</b>
10.1	Connecting to an LTC 4629 Head End Data/Video Transceiver	28
10.2	Configuring the VG5 AUTODOME Camera	28
<b>11</b>	<b>Audio Cables (AUTODOME Cameras ONLY, except VG5-600 Models)</b>	<b>31</b>

# 1 Safety

Read, follow, and retain all of the following safety instructions. Heed all warnings on the unit and in the operating instructions before operation.

## 1.1 Safety precautions



### Danger!

Indicates a hazardous situation which, if not avoided, will result in death or serious injury.



### Warning!

Indicates a hazardous situation which, if not avoided, could result in death or serious injury.



### Caution!

Indicates a hazardous situation which, if not avoided, could result in minor or moderate injury.



### Notice!

Indicates a situation which, if not avoided, could result in damage to the equipment or environment, or data loss.

## 1.2 Important safety instructions

Read, follow, and retain for future reference all of the following safety instructions. Heed all warnings on the unit and in the operating instructions before operating the unit.

1. **Cleaning** - Unplug the unit from the outlet before cleaning. Follow any instructions provided with the unit. Generally, using a dry cloth for cleaning is sufficient but a moist, fluff-free cloth or leather shammy may also be used. Do not use liquid cleaners or aerosol cleaners.
2. **Water** - Do not use this unit near water, for example near a bathtub, washbowl, sink, laundry basket, in a damp or wet basement, near a swimming pool, in an outdoor installation, or in any area classified as a wet location. To reduce the risk of fire or electrical shock, do not expose this unit to rain or moisture.
3. **Object and liquid entry** - Never push objects of any kind into this unit through openings as they may touch dangerous voltage points or short-out parts that could result in a fire or electrical shock. Never spill liquid of any kind on the unit. Do not place objects filled with liquids, such as vases or cups, on the unit.
4. **Power connection** - Protect the exit of the power connection from the unit from foot traffic, and other potential situations that could cause damage. For units intended to operate with 230 VAC, 50 Hz, the input and output power cord must comply with the latest versions of *IEC Publication 227* or *IEC Publication 245*.
5. **Power sources** - Operate the unit only from the type of power source indicated on the label. Before proceeding, be sure to disconnect the power from the cable to be installed into the unit.
  - For battery powered units, refer to the operating instructions.
  - For external power supplied units, use only the recommended or approved power supplies.

- For limited power source units, this power source must comply with *EN60950*. Substitutions may damage the unit or cause fire or shock.
  - If unsure of the type of power supply to use, contact your dealer or local power company.
6. **Servicing** - Do not attempt to service this unit yourself. Opening or removing covers may expose you to dangerous voltage or other hazards. Refer all servicing to qualified service personnel.
  7. **Damage requiring service** - Unplug the unit from the main AC power source and refer servicing to qualified service personnel when any damage to the equipment has occurred, such as:
    - exposure to moisture, water, and/or inclement weather (rain, snow, etc.);
    - liquid has been spilled in or on the equipment;
    - an object has fallen into the unit;
    - unit has been dropped or the unit cabinet is damaged;
    - unit exhibits a distinct change in performance;
    - unit does not operate normally when the user correctly follows the operating instructions.
  8. **Replacement parts** - Be sure the service technician uses replacement parts specified by the manufacturer, or that have the same characteristics as the original parts. Unauthorized substitutions may cause fire, electrical shock, or other hazards.
  9. **Safety check** - Safety checks should be performed upon completion of service or repairs to the unit to ensure proper operating condition.
  10. **Installation** - Install in accordance with the manufacturer's instructions and in accordance with applicable local codes.
  11. **Attachments, changes or modifications** - Only use attachments/accessories specified by the manufacturer. Any change or modification of the equipment, not expressly approved by Bosch, could void the warranty or, in the case of an authorization agreement, authority to operate the equipment.

## 1.3

### Important Notices

**U.S.A. models only** - *Section 810* of the *National Electrical Code, ANSI/NFPA No.70*, provides information regarding proper grounding of the mount and supporting structure, grounding of the coax to a discharge unit, size of grounding conductors, location of discharge unit, connection to grounding electrodes, and requirements for the grounding electrode.



**Disposal** - Your Bosch product was developed and manufactured with high-quality material and components that can be recycled and reused. This symbol means that electronic and electrical appliances, which have reached the end of their working life, must be collected and disposed of separately from household waste material. Separate collecting systems are usually in place for disused electronic and electrical products. Please dispose of these units at an environmentally compatible recycling facility, per *European Directive 2002/96/EC*

**Environmental statement** - Bosch has a strong commitment towards the environment. This unit has been designed to respect the environment as much as possible.

**Power lines:** An outdoor system should not be located in the vicinity of overhead power lines, electrical lights, or power circuits, or where it may contact such power lines or circuits. When installing an outdoor system, extreme care should be taken to keep from touching power lines or circuits, as this contact may be fatal. U.S.A. models only - refer to the National Electrical Code *Article 820* regarding installation of CATV systems.

**SELV** - All the input/output ports are Safety Extra Low Voltage (SELV) circuits. SELV circuits should only be connected to other SELV circuits.

Avoid connecting the SELV circuit to the Telephone Network Voltage (TNV) circuits.

#### **System ground/Safety ground**

System (video) ground is indicated by the symbol .

Safety (power) ground is indicated by the symbol .

The system ground is only used to comply with safety standards or installation practices in certain countries. Bosch does **not** recommend connecting system ground to safety ground unless it is explicitly required. However, if the system ground and safety ground are connected and grounding loops are causing interference in the video signal, use an isolation transformer (available separately from Bosch).



#### **Caution!**

Connecting System ground to Safety ground may result in ground loops that can disrupt the CCTV system.

## 1.4

### **UL certification**

#### **Disclaimer**

Underwriter Laboratories Inc. ("UL") has not tested the performance or reliability of the security or signaling aspects of this product. UL has only tested fire, shock and/or casualty hazards as outlined in UL's *Standard(s) for Safety for Closed Circuit Television Equipment, UL 2044*. UL Certification does not cover the performance or reliability of the security or signaling aspects of this product.

UL MAKES NO REPRESENTATIONS, WARRANTIES, OR CERTIFICATIONS WHATSOEVER REGARDING THE PERFORMANCE OR RELIABILITY OF ANY SECURITY OR SIGNALING RELATED FUNCTIONS OF THIS PRODUCT.

#### **Disclaimer**

Underwriter Laboratories Inc. ("UL") has not tested the performance or reliability of the security or signaling aspects of this product. UL has only tested fire, shock and/or casualty hazards as outlined in UL's *Standard(s) for Safety for Information Technology Equipment, UL 60950-1*. UL Certification does not cover the performance or reliability of the security or signaling aspects of this product.

UL MAKES NO REPRESENTATIONS, WARRANTIES, OR CERTIFICATIONS WHATSOEVER REGARDING THE PERFORMANCE OR RELIABILITY OF ANY SECURITY OR SIGNALING-RELATED FUNCTIONS OF THIS PRODUCT.

## 1.5

### **Bosch notices**

#### **Copyright**

This manual is the intellectual property of Bosch Security Systems and is protected by copyright. All rights reserved.

#### **Trademarks**

All hardware and software product names used in this document are likely to be registered trademarks and must be treated accordingly.

**Note:**

This manual has been compiled with great care and the information it contains has been thoroughly verified. The text was complete and correct at the time of printing. The ongoing development of the products may mean that the content of the user guide can change without notice. Bosch Security Systems accepts no liability for damage resulting directly or indirectly from faults, incompleteness or discrepancies between the user guide and the product described.

**More information**

For more information please contact the nearest Bosch Security Systems location or visit [www.boschsecurity.com](http://www.boschsecurity.com)

## 2 Unpacking

This equipment should be unpacked and handled with care. If an item appears to have been damaged in shipment, notify the shipper immediately.

Verify that all the parts listed in the product's Parts List below are included. If any items are missing, notify your Bosch Security Systems Sales or Customer Service Representative.

The original packing carton is the safest container in which to transport the unit and must be used if returning the unit for service. Save it for possible future use.

### 2.1 Parts List

Each VG4-A-PSU power supply box is NEMA-rated and ships with an enclosure cover and:

- Two (2) blanking plugs that fit a ½” conduit hole
- Four (4) blanking plugs that fit a ¾” conduit hole
- One (1) Installation Guide
- One (1) Quick Installation Guide (valid for AUTODOME cameras only)

### 2.2 Optional Parts List

The following table lists the optional equipment for use with the power supply boxes (applicable **only** for models that power AUTODOME cameras):

Option	Part Number
Trim skirt	VGA-A-TSKIRT
Replacement power supply box cover	VGA-SBOX-COVER
Analog Multimode Fiber Optic Kit	VGA-FIBER-AN
Ethernet Media Converter Kit	VG4-SFPCKT

**Note:** The fiber optic kits are mounted inside the power supply box. Refer to the individual kit for installation instructions.

### 2.3 Tools Required

- Small straight blade screwdrivers ~ 2.5 mm (0.1 in.) – 3.1 mm (1/8 in.)
- Medium straight blade screwdriver
- No. 1 and No. 2 Phillips screwdrivers
- Socket wrench and 9/16 in. socket
- Power drill
- Water tight conduits and fittings that meet NEMA 4 standards

### 3 Description

This manual describes how to install a VG4-A-PSUx power supply box for an AUTODOME VG5-camera, or a VG4-A-PSU1 or VG4-A-PSU2 for a MIC7000 camera. Any variations to the installation procedures are noted.

For AUTODOME cameras, these power supply boxes are intended for use with the VGA-PEND\_ARM Arm Mount, VGA-A-9543 Pipe Mount, and the VG4-A-9230 or VGA-ROOF-MOUNT Roof Parapet Mount. For complete installation, mounting, and wiring information for AUTODOME cameras, refer to the *VG5 Series AUTODOME Installation Manual* included with the packaging of the AUTODOME pendant.

The table below describes each model of VG4-A-PSU power supply:

Part Number	Rating	Applicable cameras
VG4-A-PSU1	120 VAC, 60 Hz, 1.2 A	AUTODOME cameras; MIC7000 cameras
VG4-A-PSU2	230 VAC, 50 Hz, 0.6 A	AUTODOME cameras; MIC7000 cameras

## 4 Pre-installation Check List



### Caution!

Installation must be made by qualified personnel and conform to ANSI/NFPA 70 (the National Electrical Code® (NEC)), Canadian Electrical Code, Part I (also called CE Code or CSA C22.1), and all applicable local codes. Bosch Security Systems, Inc. accepts no liability for any damages or losses caused by incorrect or improper installation.

- Determine the location and distance for the power supply box based on its voltage and current consumption.

### Power

<b>115/230 VAC</b>	
Copper Wire	To comply with local codes.

### Maximum Wire Distances from Power Supply to Analog AUTODOME Cameras

24 V to AUTODOME camera	VA / Watts	14 AWG (2.5 mm)	16 AWG (1.5 mm)	18 AWG (1.0 mm)
AUTODOME 100, Indoor	14 / 7.5	248 m (813 ft)	156 m (512 ft)	98 m (322 ft)
AUTODOME 100, Outdoor	47 / 43.5	74 m (242 ft)	46 m (152 ft)	29 m (96 ft)
AUTODOME 600, Indoor	27 / 15	129 m (422 ft)	81 m (265 ft)	51 m (167 ft)
AUTODOME 600, Outdoor <sup>1</sup>	55 / 51	63 m (207 ft)	40 m (130 ft)	25 m (82 ft)

1. Standard heater module. Add 16 W if using VG4-SHTR-XT kit.

### Maximum Wire Distances from Power Supply to AUTODOME 700 Cameras

24 V to AUTODOME camera	VA / Watts	14 AWG (2.5 mm)	16 AWG (1.5 mm)	18 AWG (1.0 mm)
AUTODOME 700, Indoor	35 / 19	99 m (325 ft)	62 m (205 ft)	39 m (129 ft)
AUTODOME 700, Outdoor <sup>2</sup>	60 / 55	58 m (190 ft)	36 m (119 ft)	23 m (75 ft)

2. Standard heater module. The VG4-SHTR-XT kit is not applicable to AUTODOME 700 Series cameras.

### Maximum Wire Distances from Power Supply to AUTODOME 7000 HD

24 V to AUTODOME 7000	VA / Watts	14 AWG (2.5 mm)	16 AWG (1.5 mm)	18 AWG (1.0 mm)
HD models with IVA, Indoor	35 / 19	99 m (325 ft)	62 m (205 ft)	39 m (129 ft)
HD models with IVA, Outdoor	60 / 55	58 m (190 ft)	36 m (119 ft)	23 m (75 ft)

- Use only UL listed liquid-tight strain reliefs for conduits to the power supply box to ensure that water cannot enter the box. You must use water tight conduits and fittings to meet NEMA 4 standards.



**Notice!**

Power and I/O cabling must be routed separately inside different permanently earthed metal conduits.

---

3. Install all rough wiring, including: power, control, video coax, alarms I/O, relay I/O, and fiber optic cabling. For video and control protocol methods for AUTODOME cameras, refer to *Video and Control Cables (AUTODOME VG5-600 Camera Models ONLY)*, page 20.

4. **For an analog AUTODOME camera only:** If you plan to use the RS-232 or RS-485 protocol to control the camera, refer to *Controlling the AUTODOME via the RS232 Protocol*, page 24, or *Controlling the AUTODOME via the RS-485 Protocol*, page 25, for instructions on configuring the camera to accept these protocols.

---



**Warning!**

External mains power cables are to be installed in accordance to NEC, ANSI/NFPA70 (for US application) and Canadian Electrical Code, Part I, CSA C22.1 (for CAN application) and in accordance to local country codes for all other countries.

Branch circuit protection incorporating a 20 A, 2-pole Listed Circuit Breaker or Branch Rated Fuses are required as part of the building installation. A readily accessible 2-pole disconnect device with a contact separation of at least 3 mm must be incorporated.

---

5. Purchase the appropriate mounting hardware to use, depending on the location of the power supply box.

## 5 Mount Power Supply Box (Wall, Mast (Pole), and Corner Mounts)

Before mounting the Power Supply Box, decide if you should wire the box through the holes in the bottom or back of the box. If wiring the box through the back, move the two (2) seal plugs to the bottom through the holes before mounting.



### Notice!

Use 3/4-inch (20-mm) NPS fittings for the holes on the bottom and back of the box. Use 1/2-inch (15-mm) NPS fittings for the side holes.

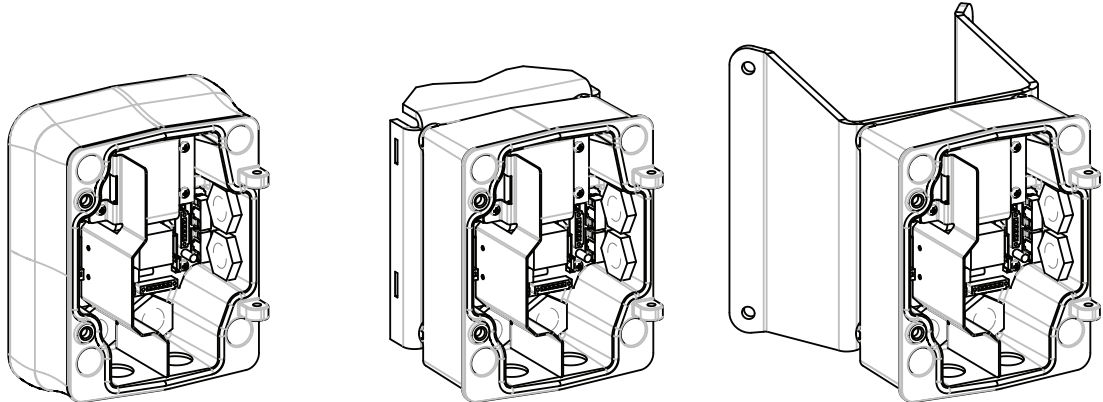

**Figure 5.1: Power Supply Wall, Mast (Pole), and Corner Mounts**

1. Use the wall mount template supplied in the packaging box to locate the four (4) mounting holes for the Power Supply Box.
2. Drill four (4) holes for the mounting anchors. If installing outdoors, apply a weatherproof sealant around each hole at the mounting surface.



### Warning!

A stud diameter of 6.4 mm (1/4 inch) to 8 mm (5/16 inch) able to withstand a 120 kg (265 lb) pull-out force is recommended. The mounting material must be able to withstand this pull out force. For example, 19-mm (3/4-inch) minimum for plywood.

3. Place the Power Supply Box into the optional Trim Skirt.
4. Secure the Power Supply Box to the mounting surface.
  - For a Wall installation: Use four (4) corrosion-resistant, stainless steel studs (not supplied). Then proceed to Step 5 below.
  - For a Corner installation: Secure the Corner Plate to the wall corner using four (4) studs (not included). Then proceed to Step 5 below.
  - For a Mast or a pole installation: The metal straps included with the Mast mount accommodate a pole with a diameter of 100–380 mm (4–15 in.). You must use a banding tool (sold separately) for a mast or pole installation. Follow the instructions provided with the banding tool to securely mount the Mast Plate to the pole. Contact your Bosch Sales Representative to order Banding Tool P/N TC9311PM3T.
5. Secure the Power Supply Box to the Corner Plate or Mast Plate using the four (4) 3/8 x 1-3/4-inch bolts and split lock washers (supplied).
6. Attach 3/4-inch (20-mm) NPS watertight, earth-grounded conduit pipe fittings (not supplied) to the bottom or back holes of the Power Supply Box through which you will run the power, video, and control data wires.



**Warning!**

For units intended to be installed outdoors: All wiring (power and I/O cabling) connecting to the unit must be routed separately inside different permanently earthed metal conduits (not supplied).

---

## 6 Attach Cover Door to Power Supply Box

1. Compress the bottom hinge pin by pushing the pin lever down and then rotate it behind the Hinge Pin Stop. The power box Cover Door provides a Hinge Pin Stop to hold the bottom hinge open while attaching the door.

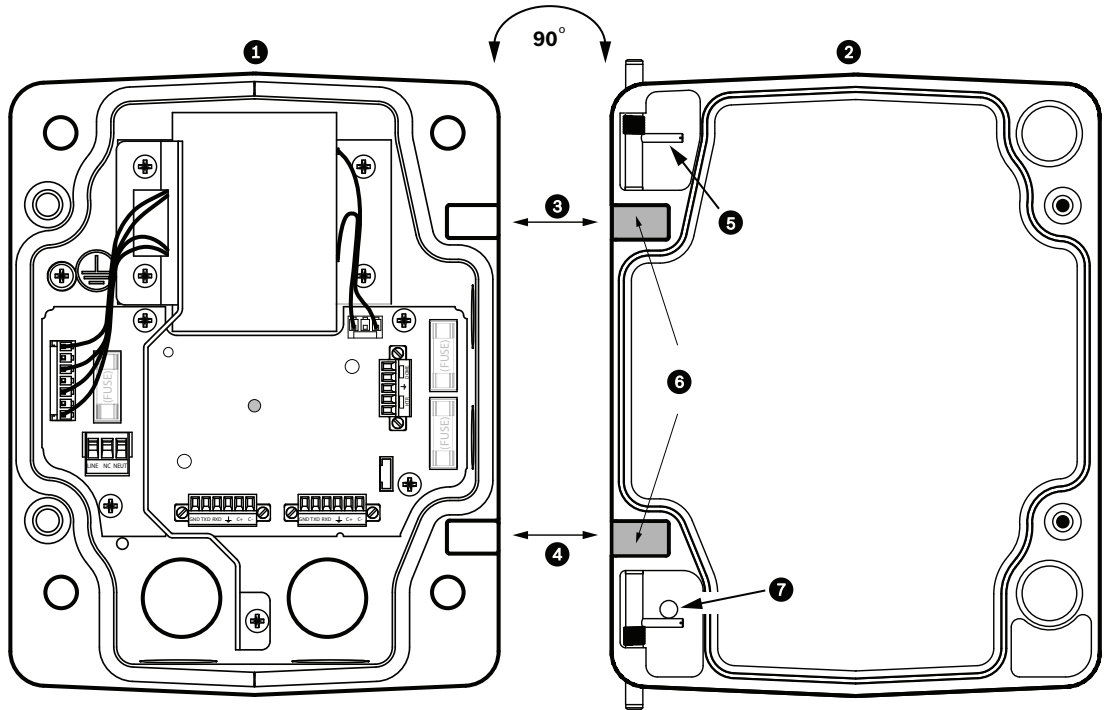

Figure 6.1: Align Cover Door Hinge to Power Box

1	Power Supply Box	5	Hold Hinge Pin Open
2	Cover Door	6	Open Position
3	Align Top Hinge	7	Hinge Pin Stop
4	Align Bottom Hinge		

2. Open the top hinge by pushing its pin lever outward and holding it open.  
**Note:** Both Hinge Pins must be fully compressed to open (unlock) the female hinges of the Cover Door before proceeding to the next step.
3. While holding the top hinge pin open, position the Cover Door to the Power Supply Box and align its hinges.
4. When the hinges are aligned, release the top hinge pin to engage its mating hinge on the power box. Then release the bottom hinge pin from the Hinge Pin Stop to complete attaching the Cover Door to the Power Supply Box.



**Notice!**

After all wiring is complete, close the cover door and tighten the two (2) captive screws on the cover door to 10-12 N-m (90-105 in.-lbs) to ensure the Power Supply Box is watertight.

## 7 Route Wires and Attach Connectors

Power wires must be routed to the left (front) side of the Power Supply Box through a separate electrically earth-grounded conduit. All video, control, and alarm wires must be routed through a second electrically earth-grounded conduit to the right side of the box.



### Warning!

External interconnecting cables are to be installed in accordance to NEC, ANSI/NFPA70 (for US application) and Canadian Electrical Code, Part I, CSA C22.1 (for CAN application) and in accordance to local country codes for all other countries.

Branch circuit protection incorporating a 20 A, 2-pole Listed Circuit Breaker or Branch Rated Fuses are required as part of the building installation. A readily accessible 2-pole disconnect device with a contact separation of at least 3 mm (0.12 in.) must be incorporated.

### 7.1 Methods for Routing Wires (AUTODOME Cameras ONLY)

There are two possible methods to route the video, control, and alarm wires:  
 Method One is to route the video, control, and alarm wires through the conduit fitting on the right (front) side of the Power Supply Box and out to the AUTODOME Interface Board.

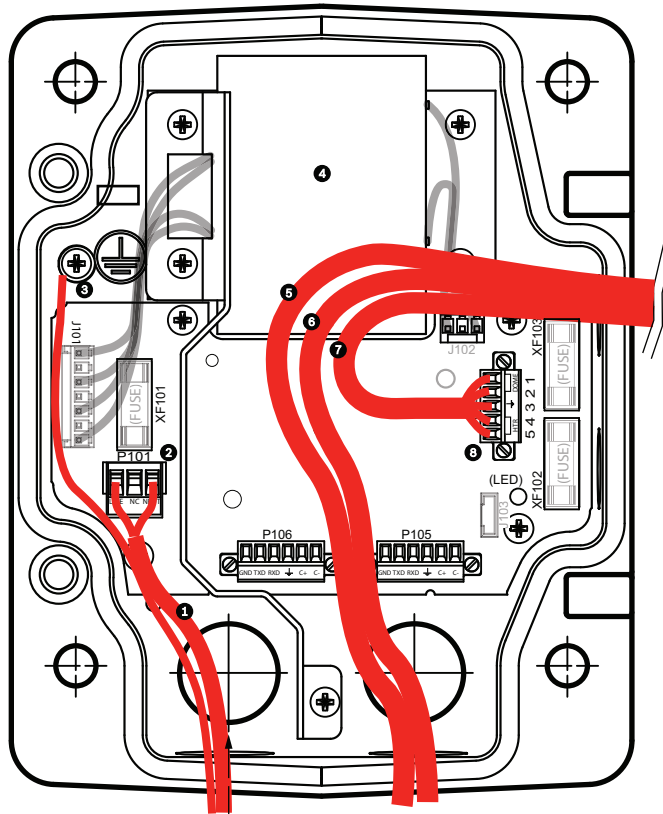

Figure 7.1: VG4-A-PSU1 or VG4-A-PSU2 Power Supply Box

1	120 VAC/230 VAC Power In	6	Control Wire Used for Audio input and output in AUTODOME 7000 Series.
2	P101 Connector	7	24 VAC Power Out
3	Ground Connection	8	P107 Connector

4	Transformer	9	Earth-grounded conduit with power input and earth-ground connection
5	Ethernet Wire	10	Earth-grounded conduit with Ethernet video/control, audio input and output to "head-end" system
		11	Earth-grounded conduit to camera

Method Two is to bypass the Power Supply Box and route the video, control, and alarm wires directly to the Interface Board. You connect only the power wires inside the Power Supply Box. All conduit and junction boxes used must be electrically earth-grounded.

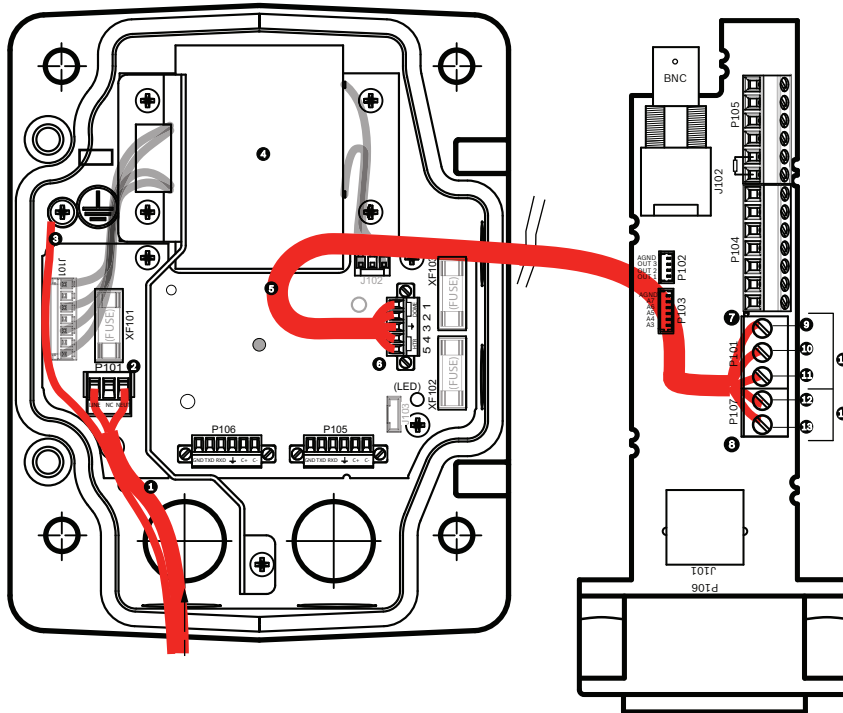

Figure 7.2: VG4-A-PSU1 or VG4-A-PSU2 Power Supply Box Connected to Pipe Interface Board

	VG4-A-PSU1/VG4-A-PSU2		Pipe Interface Board
1	120 VAC/230 VAC Power In	7	P101 Connector
2	P101 Connector	8	P107 Connector
3	Ground Connection	9	24 VAC Power In (to camera)
4	Transformer	10	Earth Ground
5	24 VAC Power Out	11	24 VAC Power In (to camera)
6	P107 Connector	12	24 VAC Power In (to Heater)
		13	24 VAC Power In (to Heater)
		14	Camera Power
		15	Heater Power

## 7.2 Power Supply Box Connections

The following figure is a detailed illustration of the power supply box, which includes the fuse specifications.

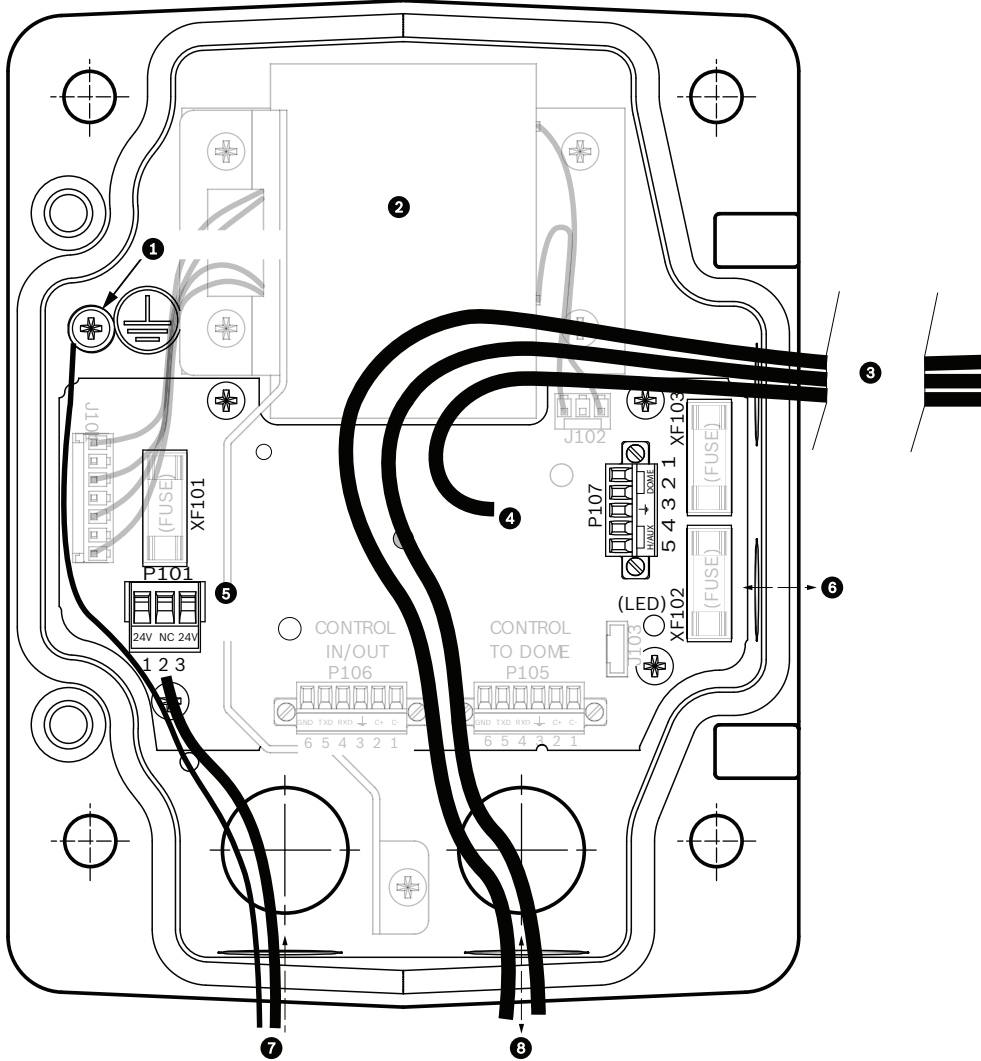

Figure 7.3: Layout of Power Supply Box. (Wire connections applicable for AUTODOME cameras.)

1	Ground Screw	5	Power In
2	Transformer (115/230 VAC Models)	6	In/Out; 1/2 in. (15 mm) NPS Fitting
3	In/Out to Dome	7	Power In; 3/4 in. (20 mm) NPS Fitting
4	24 VAC to Dome Interface Board	8	Control Data and Video In/Out; 3/4 in. (20 mm) NPS Fitting



**Warning!**

Fuse replacement by qualified service personnel only. Replace with same type fuse.

Fuse Specifications			
Volts	XF101 Mains	XF102 Camera	XF103 Heater
24 V	T 5.0 A	T 2.0 A	T 3.15 A
115 V	T 1.6 A	T 2.0 A	T 3.15 A
230 V	T 0.8A	T 2.0 A	T 3.15 A

**Power Box Connections - AUTODOME**

The following table lists the Power Supply Box connectors for AUTODOME cameras.

No.	Connector	Pin 1	Pin 2	Pin 3	Pin 4	Pin 5	Pin 6
	Ground	Grounding Screw					
P101	115/230 VAC Power In	Line	NC	Neutral			
P105 <sup>1</sup>	Control to Dome (Fiber Optic Model)	C- (Biphase)	C+ (Biphase)	Earth Ground	RXD (+) (RS-232/485)	TXD (-) (RS-232/485)	Signal Ground
P106 <sup>1</sup>	Control In/Out (Optional)	C- (Biphase)	C+ (Biphase)	Earth Ground	RXD (+) (RS-232/485)	TXD (-) (RS-232/485)	Signal Ground
P107	24 VAC Power to Dome Plug	Dome 24 VAC	Dome 24 VAC	Earth Ground	Heater (24 VAC)	Heater (24 VAC)	

1. Applicable to VG5 100 and 600 Series AUTODOME cameras only.

## 8 Wiring the Power Supply Box

1. Route the high voltage 115/230 VAC lines through the conduit fitting on the left side of the box.

or

Route the 24 VAC lines through the conduit fitting on the left side of the box.



### **Notice!**

The power supply box with transformer comes with a barrier that separates the high voltage side on the left from the low voltage 24 VAC side on the right.

2. Cut and trim the high voltage 24/115/230 VAC power and ground wires with sufficient slack to reach their connector terminal in the box, but not so long as to be pinched by or to obstruct closing the cover door.

3. Attach the supplied 3-pin power plug to the incoming high voltage power wires in the box. Refer to connector P101 in .

5. Route the low power 24 VAC wires from the right side of the power supply box out to where the camera will be mounted. Attach the supplied 5-pin 24 VAC Dome plug to the wire ends inside the box. Refer to connector P107 in .

## 9 Video and Control Cables (AUTODOME VG5-600 Camera Models ONLY)

This chapter applies only to AUTODOME cameras.

### 9.1 Using Coaxial Cable to Transmit Video and Control

#### Caution!

^



**600 Series AUTODOME:** If you are using coaxial cable to transmit video and data between the camera and the head-end, you must use the coax cable with ferrite included in the camera packaging. You must connect the incoming coax cable (from the head-end) to the jack (female end) on the ferrite cable and connect the plug end (male connector) of the ferrite cable to the camera's coax connector.

Coaxial cable terminated with BNC connectors is the most common method for transmitting composite video. Bilinx control data can also be sent over the same cable.

Bilinx is a Bosch 2-way communication protocol that allows remote control, configuration, and updates over a video coax cable. Bilinx is available on all VG5 100 and 600 Series cameras. AUTODOME VG5 Series cameras feature cable compensation or "Pre-Comp," which extends the range of video from the head end.

Cable Compensation	Maximum Distances		
	Video Only		Bilinx Control
Cable Type	Pre-comp OFF	Pre-comp ON	Pre-comp ON or OFF
RG-59/U	300 m (1000 ft)	600 m (2000 ft)	300 m (1000 ft)
RG-6/U	450 m (1500 ft)	900 m (3000 ft)	450 m (1500 ft)
RG-11/U	600 m (2000 ft)	1200 m (4000 ft)	600 m (2000 ft)
Size	O.D. between 4.6 mm (0.181 in.) and 7.9 mm (0.312 in.)		
Shield	Copper braid: 95%		
Central Conductor	Standard copper center		
Terminal Connector	BNC		



#### Warning!

Cable compensation (Pre-Comp) does not extend the range of Bilinx control. Pre-Comp is not available with VG5 700 Series cameras.

### 9.2 Using UTP to Transmit Video and Control

Unshielded twisted pair (UTP) cable terminated with RJ45 male connectors are used to transmit composite video using pins 1(+) and 2(-). Typically, a Coax to UTP cable converter is required at the head-end of the system.

Bilinx control data can also be sent over the same two video wires (1 & 2). Bilinx is a Bosch 2-way communication protocol that allows remote control, configuration and updates over a passive UTP cable.

VG5 100 and 600 Series cameras feature cable compensation or “Pre-Comp,” which extends the normal range of control from the head end.



**Warning!**

Do not connect the RJ45 connector unless using UTP video.

Cable Compensation	Maximum Distance	
	Pre-comp OFF	Pre-comp ON
Cable Type	229 m (750 ft)	450 m (1500 ft)
Terminal Connector	RJ45	
Requirement	Coax to UTP Converter	

The following figure illustrates the connections necessary to transmit video and control over a UTP cable.

### 9.3

## Using Ethernet to Transmit Video and Control



**Caution!**

Ethernet connections must be made to non-exposed (indoor) networks only.

The AUTODOME VG5 Series camera connects to a 10 Base-T/100 Base-TX network either directly or via a switch. Both video and control are transmitted over a standard TCP/IP network using the built-in Web server.

Cable Type	CAT-5E or CAT 6 Ethernet
Maximum Distance	100 m (328 ft)
Bandwidth	10 Base-T/100 Base-TX
Terminal Connector	RJ45, Female



**Warning!**

Do not connect a coaxial cable while the RJ45 Ethernet cable is connected.

### 9.4

## Using Multi-mode Fiber Optic to Transmit Video and Control

Fiber Optic kits, available for AUTODOME 100 and 600 Series cameras, transmit both video and Biphase control over an analog singlemode or multimode fiber.

Multimode	
Fiber Type	50/125 $\mu\text{m}$ , 62.5/125 $\mu\text{m}$ , low loss multimode glass fiber
Maximum Distance	4 km (2.5 miles)
Minimum Bandwidth	20 MHz (Video - 850 nm / Control - 1300 nm)

<b>Multimode</b>	
Requirement	Bosch LTC 4629 Fiber Receiver at controller end of system
Terminal Connector	ST
<b>Singlemode</b>	
Fiber Type	9/125 $\mu\text{m}$ , low loss single glass fiber
Maximum Distance	69 km (43 miles)
Minimum Bandwidth	20 MHz (Video - 1310 nm /Control - 1550 nm)
Requirement	Single mode fiber receiver at controller end of system
Terminal Connector	ST

## 9.5 Using a Fiber Optic Ethernet Media Converter to Transmit Video and Control

The fiber optic media converter kit, available for AUTODOME 700 Series cameras, is designed to transmit 10/100 Mbps Ethernet signals over fiber optic cable using 10/100 Mbps Small Form-factor Pluggable (SFP) modules. The SFP modules are available as multi-mode fiber (MMF) or single-mode fiber (SMF) models with a single SC connector or dual-fiber with an LC connector. Refer to the *VG4-SFPSCKT Fiber Optic Media Converter Installation Guide*.

<b>Ethernet Media Converter</b>	
Data Interface	Ethernet
Data Rate	10/100 Mbps IEEE 802.3 Compliant Full Duplex or Half Duplex Electrical Port Full Duplex Optical Port
Fiber Type, MMF	50/125 $\mu\text{m}$ MMF. For 50/125 $\mu\text{m}$ fiber, subtract 4 dB from the specified optical budget value. Must meet or exceed fiber standard ITU-T G.651.
Fiber Type, SMF	8–10/125 $\mu\text{m}$ SMF. Must meet or exceed fiber standard ITU-T G.652.
Maximum Distance	60 km (37.3 miles)
Requirement	Media converter receiver (CNFE2MC/IN) at controller end of system
Terminal Connection	Duplex LC or Single SC

## 9.6 Controlling the AUTODOME via Biphase

(Shielded 2-wire, half-duplex, multi-drop, 5000 ft. cable limit)

Biphase is the standard Bosch protocol used to send Pan/Tilt/Zoom control over 2-wire shielded twisted pair (STP) terminated with a 100  $\Omega$  terminal resistor.

The cameras has a 100  $\Omega$  termination resistor between the Biphase C+ and C- terminals.



**Caution!**

The Biphase shield must be connected to the head end only.

Cable Type	STP - Shielded Twisted Pair
Distance	1524 m (5000 ft) Belden 8760 recommended
Transmission Rate	31.25 KHz
Gage	1.02 mm (18 AWG)
Termination	100 Ω
Terminal Connector	Screw terminals
Voltage	4 Vp-p

The figure below illustrates the connections necessary for Biphase operation.

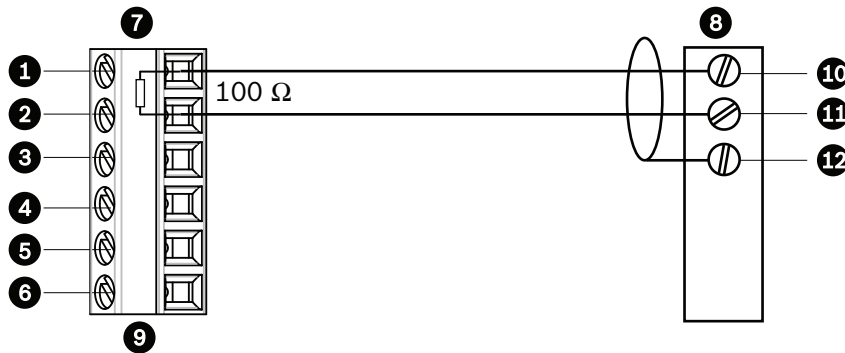

**Figure 9.1: Connections for Biphase Operation**

1	C- (Biphase)	7	AUTODOME Data In/Out
2	C+ (Biphase)	8	Head End Biphase
3	Earth Ground	9	P105/P106 Connector in Power Supply Box
4	RxD	10	C- (Biphase)
5	TxD	11	C+ (Biphase)
6	Signal Ground	12	Shield

In a daisy chain configuration, where multiple domes are connected in series, the 100 Ω resistor must be removed from all but the last dome. You can daisy chain a maximum of four (4) AUTODOME cameras.

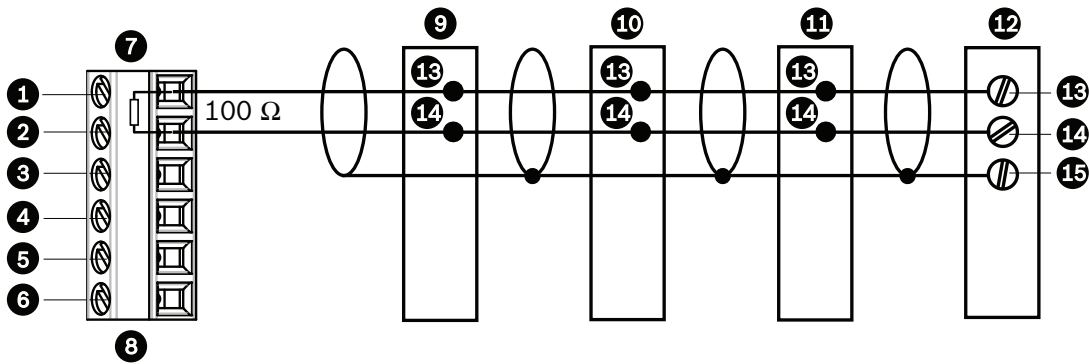

Figure 9.2: Connections for a Daisy Chain Configuration

1	C- (Biphase)	9	Dome 3
2	C+ (Biphase)	10	Dome 2
3	Earth Ground	11	Dome 1
4	RxD	12	Head End Biphase
5	TxD	13	C- (Biphase)
6	Signal Ground	14	C + (Biphase)
7	Last Dome Data In/Out	15	Shield
8	P105/P106 Connector in Power Supply Box		

## 9.7 Controlling the AUTODOME via the RS232 Protocol

(3-wire, full-duplex, single-ended, 50 ft. cable limit)

RS232 is a common, single-ended communication protocol used for control. Data transmission via 3-wires (TXD, RXD, common) is from one transmitter to one receiver at relatively slow baud rates (up to 57.6 Kbaud) and short distances up to 50 ft.



### Notice!

After making the wire connections for RS232 operation, reposition the slide switch located on the CPU Module to the camera head inward and away from the LEDs.

Wire Type	3-wire (TXD, RXD, common)
Distance	15 m (50 ft)
Maximum Baud Rate	57.6 Kb
Voltage	± 15 V
Termination	100 Ω
Slide Switch	Away from LEDs (factory default)

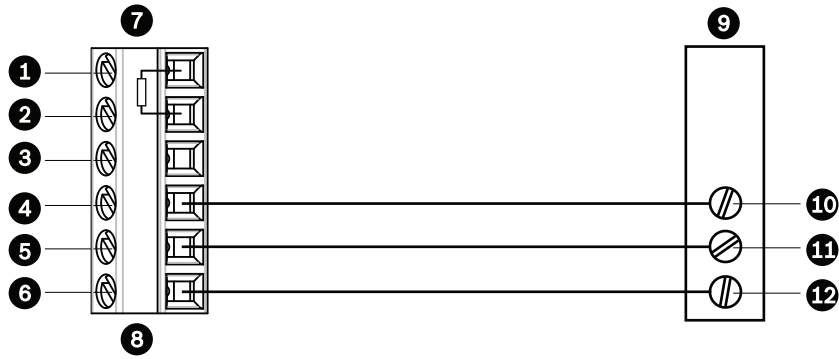

Figure 9.3: Connections for RS232 Operation

1	C- (Biphase)	7	AUTODOME Data In/Out
2	C+ (Biphase)	8	P105/P106 Connector in Power Supply Box
3	Earth Ground	9	Head End RS232
4	RxD	10	TxD
5	TxD	11	RxD
6	Signal Ground	12	Ground

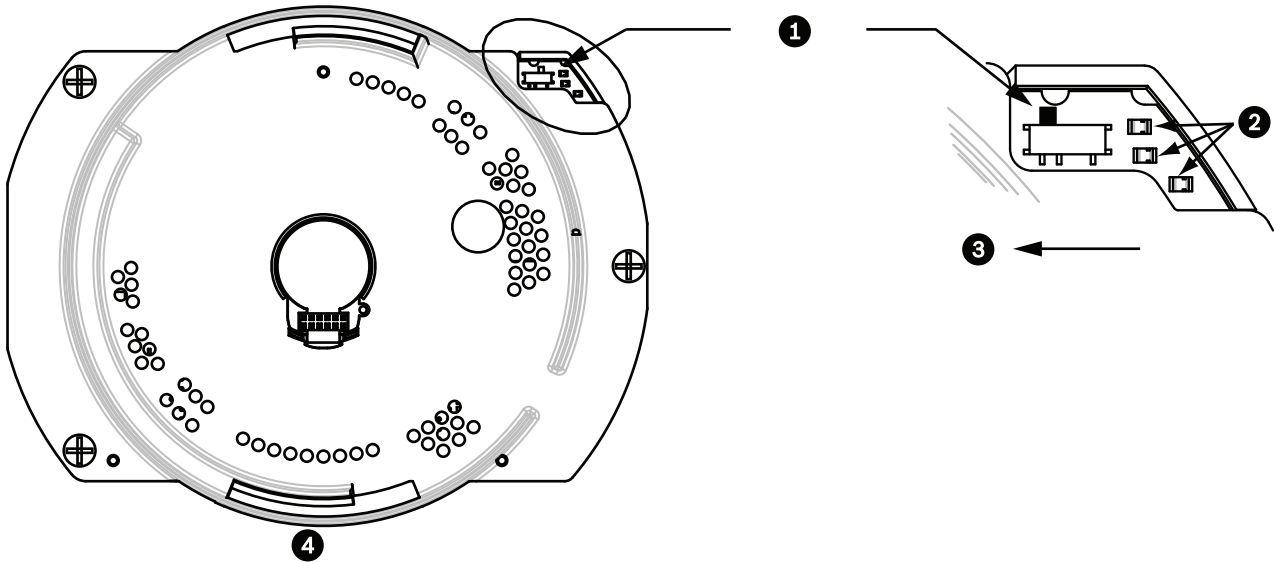

Figure 9.4: Position of CPU Switch for RS232 Operation (camera module not shown for clarity)

1	Switch Location
2	LEDs
3	RS232
4	CPU Module

**Note:** To access the CPU switch you must remove the bubble from the pendant housing.

## 9.8

### Controlling the AUTODOME via the RS-485 Protocol

2-wire (shielded), half-duplex, differential, multi-drop (32 nodes), 4000 ft cable limit)

RS-485 is capable of controlling a true multi-drop network and is specified for up to 32 drivers and 32 receivers on a single 2-wire bus. The AUTODOME camera uses the 2-wire mode, although RS-485 can be connected in a 2- or 4-wire mode.



**Notice!**

The wire shield must be tied to signal at both ends, if 2-wire twisted pair is used. After connecting the wires for RS-485 operation, make sure the slide switch on the main board to the camera head is positioned toward the LEDs (default).



**Caution!**

Bosch recommends that multiple RS-485 connections be arranged as a connected series of point-to-point (multi-dropped) nodes, as a line or as a bus. It is **not** recommended to arrange RS-485 connections as a star, ring, or as a multiple-connected network. Star and ring topologies may cause signal reflections or excessively low or high termination impedance.

Wire Type	2-wire shielded twisted pair
Distance	1219 m (4000 ft)
Maximum Baud Rate	57.6 kb
Gage	0.511 mm (24 AWG)
Wire Impedance	120 W
Slide Switch	Toward LEDs (factory default)

The following figure illustrates the connections for RS-485 connections.

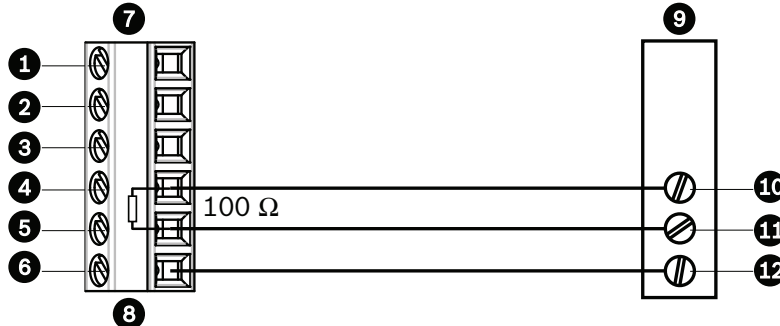

**Figure 9.5: Connections for RS485 Operations**

1	C- (Biphase)	7	AUTODOME Data In/Out
2	C+ (Biphase)	8	P105/P106 Connector in Power Supply Box
3	Earth Ground	9	Head End RS-485
4	RxD	10	Data +
5	TxD	11	Data -
6	Signal Ground	12	Ground

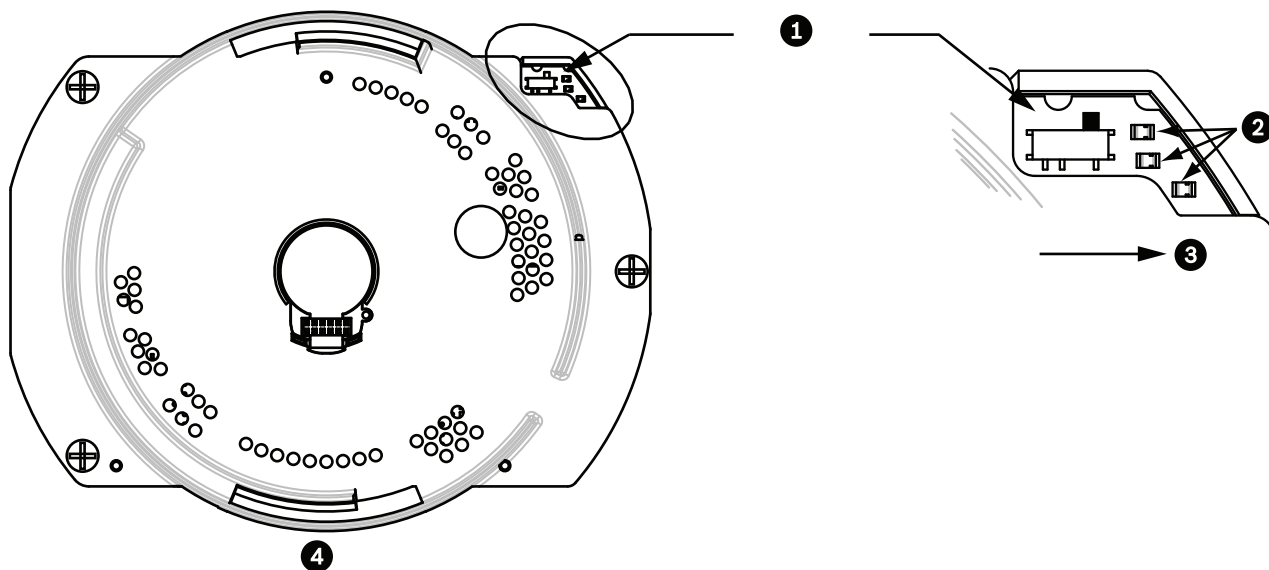

Figure 9.6: Position of CPU Switch for RS-485 Operation (camera module not shown for clarity)

1	Switch Location
2	LEDs
3	RS-485
4	CPU Module

**Note:** To access the CPU switch, you must remove the bubble from the pendant housing.

## 10 Fiber Optic Module with an RS232/RS422 Controller (AUTODOME VG5-600 Camera Models ONLY)

This chapter applies only to AUTODOME cameras.

An AUTODOME camera with a fiber optic module is prewired to operate with Biphase signals only. This section describes the procedures necessary to control a VG5 Series camera fitted with a fiber optic kit using an RS-232 controller or a Pelco® RS-422 controller.

To control a VG5 Series camera from an RS-232 or from a Pelco RS-422 controller, you must run control wires from the controller to an LTC 4629 head-end fiber optic module.

### 10.1 Connecting to an LTC 4629 Head End Data/Video Transceiver

1. Connect the RS-232 cable (TxD from the controller) to the RS-232 RxD port (pin 1) of the LTC 4629.
2. Connect the ground wire of the controller to Pin 2 on the LTC 4629.

### 10.2 Configuring the VG5 AUTODOME Camera

1. Disconnect the power to the VG4 power supply unit; then open the unit.
2. Remove the green Serial Communications wire from the P106 connector.
3. Remove the 100  $\Omega$  resistor across the C+ and C- pins.
4. Cut the five wires from the green Serial Communications wire mating connector. Ensure that the insulation covers each wire to avoid wires from touching.
5. Cut back the insulation on the blue (ground) wire and on the green (RxD) wire enough to be able to connect these wires back into the P106 connector.
6. Connect the blue (ground) wire to the C- pin on the P106 connector.
7. Connect the green (RxD) wire to the C+ pin on the P106 connector.

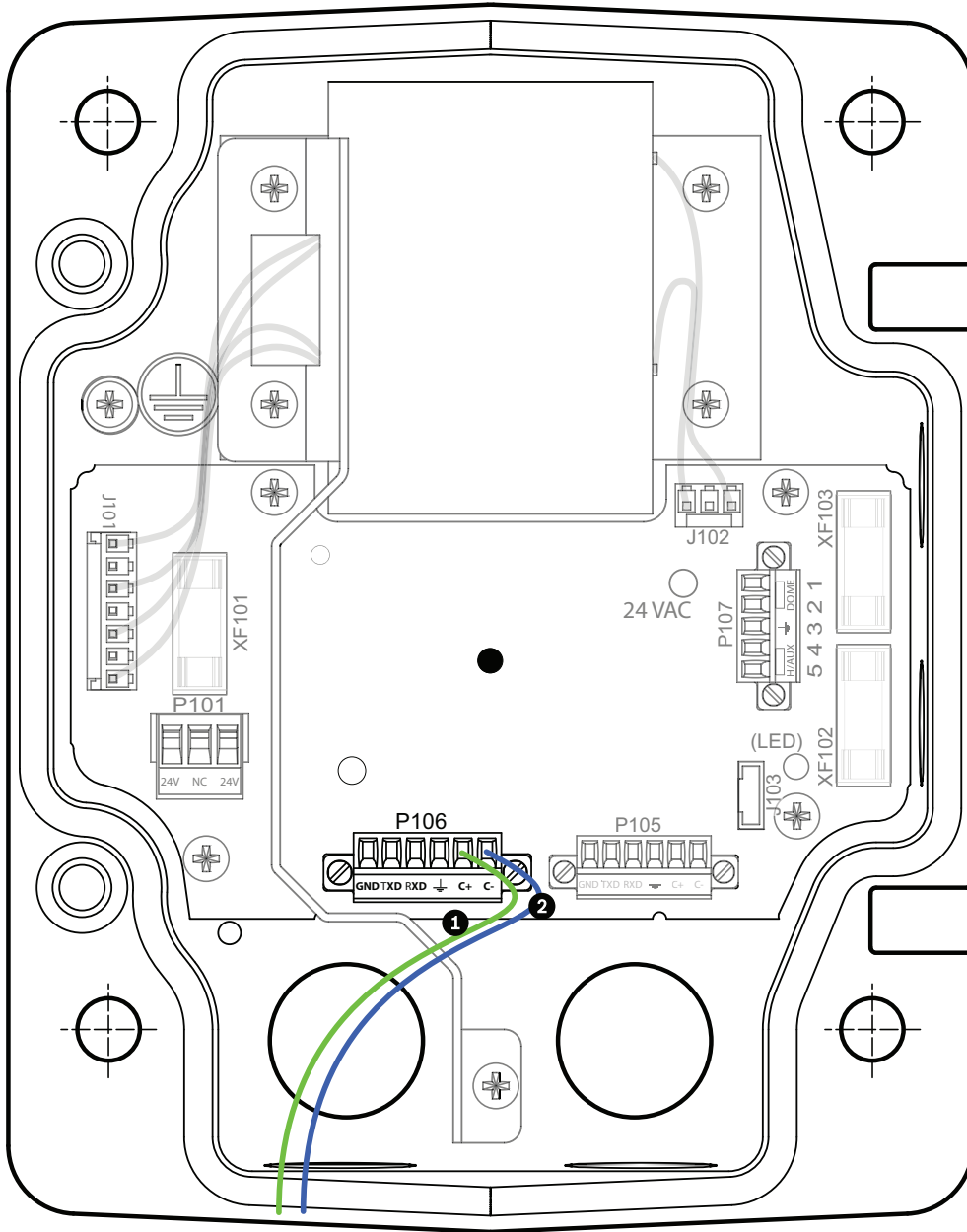

**Figure 10.1: Detail of P106 Connections**

1	Green RxD wire connected to C+
2	Blue Ground wire connected to C-

8. Connect the fiber optic cable from the camera to the LTC 4629.
9. Close the door to the power supply unit.
10. Ensure that the camera is set to receive RS-232 commands.
  - Remove the bubble from the camera housing.
  - Locate the protocol switch on the CPU board.

- Ensure that the protocol switch is in the left position for RS-232 operation.

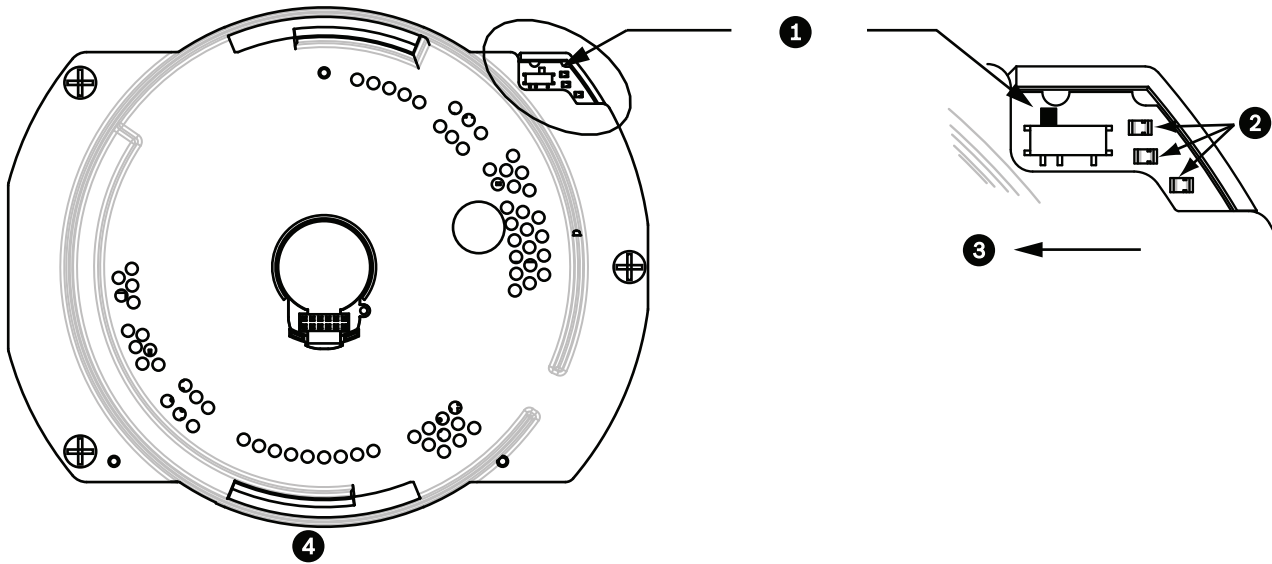

Figure 10.2: Position of CPU Switch for RS-232 Operation

1	Switch Location
2	LEDs
3	Move Switch to the left for RS-232 Operation
4	CPU Module

11. Return the bubble to the camera housing.
12. Return power to the power supply box.

# 11

## Audio Cables (AUTODOME Cameras ONLY, except VG5-600 Models)

This chapter applies only to AUTODOME cameras.

AUTODOME cameras of the VG5 700 Series, the VG5 800 Series, and the 7000 Series are capable of receiving line input audio signals and transmitting it over a network. The audio signal is transmitted one-way and in sync with the video signals.

### Audio Line Input Specifications

<b>Max. Input Voltage</b>	<b>5.5 Vpp</b>
Impedance	9K $\Omega$
Sample Rate	8 K Hz, 16 Bit, mono
Shield	Bare copper braid: 95% coverage
Internal gain level adjustment is available	

### Wire Specifications

<b>Wire Type</b>	<b>Coax<sup>3</sup> (recommended)</b>
Distance	10 m (33 ft)
Gage	22 AWG to Biphase connector (P105/P106)
Shield	Bare copper braid: 95% coverage
Center conductor	Stranded bare copper



### Notice!

Separate the audio cables from the AC power lines to avoid noise.

### Audio Connections

1. Remove the 100  $\Omega$  termination resistor from the Biphase terminals.
2. Connect the audio line level source to the Biphase C+ input terminal.
3. Connect the audio signal ground to the Biphase C- input terminal.

The following figure illustrates the connections for audio over an IP network.

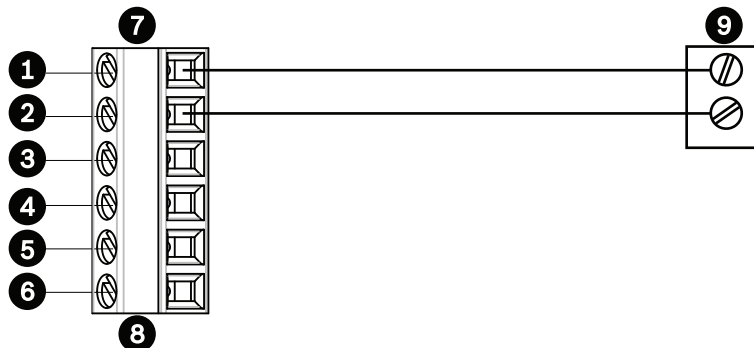

**Figure 11.1: Connections for audio over an Ethernet network**

1	C- (audio line level source)	7	AUTODOME Data In/Out
2	C+ (audio signal ground)	8	P105/P106 Connector

---

3	Earth Ground	9	Audio Input
4	RxD ( <i>not used</i> )		
5	TxD ( <i>not used</i> )		
6	Signal Ground ( <i>not used</i> )		

---

**Notice!**

Refer to the *Installation Manual of your camera* for configuring and using audio over an IP Ethernet network.

---



**Bosch Sicherheitssysteme GmbH**

Robert-Bosch-Ring 5

85630 Grasbrunn

Germany

**[www.boschsecurity.com](http://www.boschsecurity.com)**

© Bosch Sicherheitssysteme GmbH, 2017

**Bosch Security Systems, Inc**

1706 Hempstead Road

Lancaster, PA, 17601

USA